

Easier to use the Standard CNC from FANUC

FANUC

Series *0i*-MODEL F Plus



FANUC's New Standard CNC

FANUC Series Oi-MODEL F PLUS

More powerful and easier to use

Mach
Perform

- Improved visibility and operability with renewal design of screen
- Equipped with *i*HMI for consistent support at shop floor
- Equipped with FANUC's latest CNC and Servo technologies
- Customizable functions for characteristic screens and operation as standard
- Extended memory capacity for storing large sized program
- CNC-QSSR for easy robots connection and control

Reduced cycle

▶ Fast Cycle-time

Achieves high-q

▶ Fine Surface



Prevent sudden machine downtime with preventive maintenance

▶ Extensive failure prediction functions

Reduce recovery time by easily pinpointing faulty parts

▶ Diagnosis/maintenance functions

Minimizing Downtime

us

aining
mance

time
e Technology

quality machining
Technology

Two-product line-up covering different purposes

CNC for Machining Center

FANUC Series Oi-MF Plus

1-path system total controllable axes: up to 12
2-path system total controllable axes: up to 14
Simultaneous controlled axes : up to 4 axes

CNC for Lathe

FANUC Series Oi-TF Plus

1-path system total controllable axes: up to 15
2-path system total controllable axes: up to 18
Simultaneous controlled axes : up to 4 axes

(Total controllable axes:
total of feed axes and spindles
(including Loader control system))

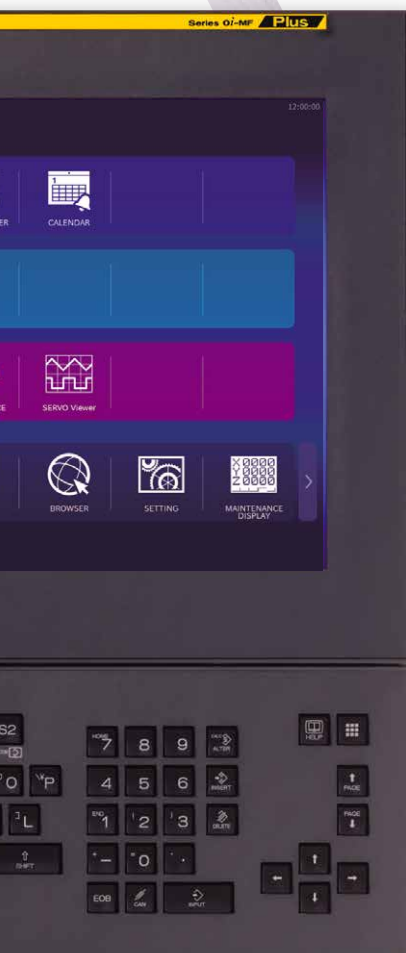

Ease of Use

Consistent support at shop floor
▶ FANUC iHMI

Original screen for ease of use
▶ Comes standard with customizable functions

IoT integration
▶ Extensive compatibility with field networks

System configuration

CNC control unit (LCD mounted type/stand-alone type)

Line-up of displays that are compatible with the various types of machine tools, from compact to large and standard to high-spec, such as the FANUC *i*PC, PANEL *i*H compatible with *i*HMI and the compact 10.4" LCD/MDI unit.



FANUC *i*PC
24"



FANUC *i*PC
21.5"



FANUC *i*PC
15"



PANEL *i*H/*i*H Pro
15"/10.4" LCD



10.4" LCD/MDI



Handheld unit

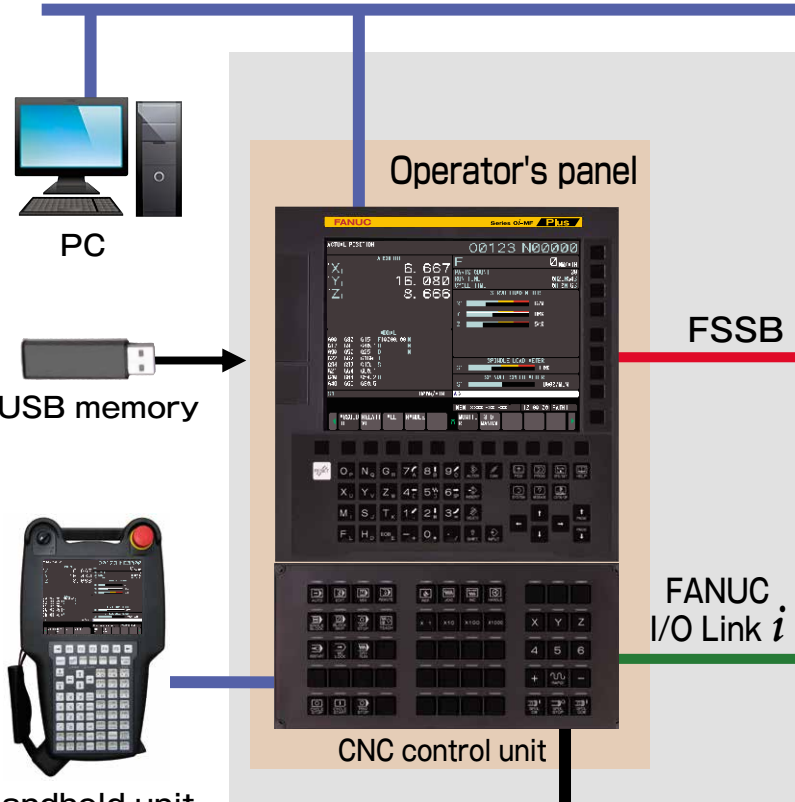

Handheld unit

Equipped with an emergency stop button and a manual pulse generator, this handy unit line-up achieves safe manual operation of machine tools.



*i*Pendant



Handy Machine
Operator's Panel



Portable manual
pulse generator

I/O Unit

Wide range of I/O units compatible with various installation locations and I/O devices.

Optimized for operator's panels with its thin and space-saving design

Standard operator's panel with
key input duplication



Safety Machine
operator's panel

Handles the output/input
of safety signals



I/O module for operator's panel
supporting safety function

Compatible with original
operator's panels



I/O module for
operator's panel

Optimized for control cabinets
multi-point output/input type

Excellent cost performance
with multi-point output/input



I/O unit for power
magnetics cabinet

Compact and with
reduced wiring



I/O unit for
connector panel

Ethernet

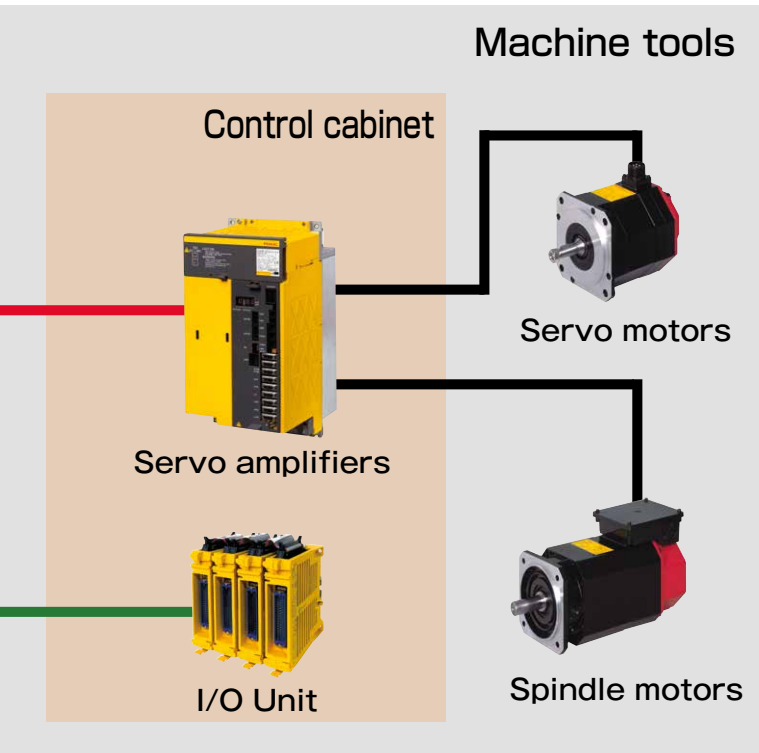

Servo motor

Line-up to meet the various needs of machine tools and contribute to the performance improvement of feed axes



AC SERVO MOTOR
 α i-B/ β i-B series



DD MOTOR
DiS-B series

Spindle motor

Line-up to meet the various needs of machine tools and contribute to the performance improvement of spindles



AC SPINDLE MOTOR
 α i-B/ β i-B series



BUILT-IN SPINDLE MOTOR
Bi-B series

networks

Peripheral equipment

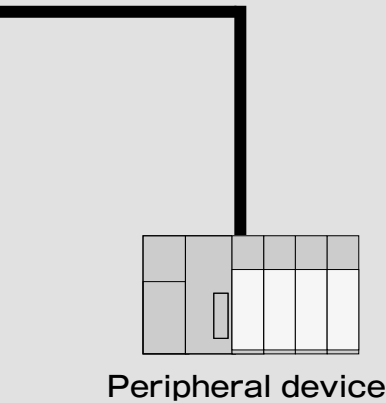

Compatible with various field networks

- FL-net
- EtherNet/IP
- PROFINET
- Modbus/TCP
- CC-Link IE Field
- PROFIBUS-DP
- DeviceNet
- CC-Link

Servo amplifier

Line-up to be flexibly available for a variety of machine tools and contribute to the downsizing of cabinets



SERVO AMPLIFIER
 β iSVSP-B series



SERVO AMPLIFIER
 α i-B series

with high scalability and extensive modules such as the and the analog/digital output/input module

Reduced wiring work with a dismantlable pole terminal block



Terminal Type I/O unit

Effective for thermal displacement compensation with multi-point temperature sensor input

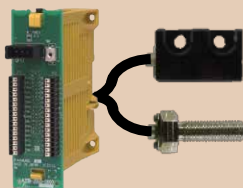

Temperature sensor input unit

Extensive modules including analog, temperature input, and high-speed counter



I/O Unit-MODEL A

Optimized for reduced wiring by enabling distributed setup

Can be positioned near sensors scattered inside and outside the machine cabinet

IP67 type



I/O Unit-MODEL B

High performance

Fast Cycle-time Technology

Fast Cycle Time Technology refers to CNC and servo technologies that achieve reduced cycle times. It reduces cycle times of machining programs through methods such as accelerating and decelerating depending on the operational state, making the best use of spindle performance, and reducing the sequence processing time for external signals.

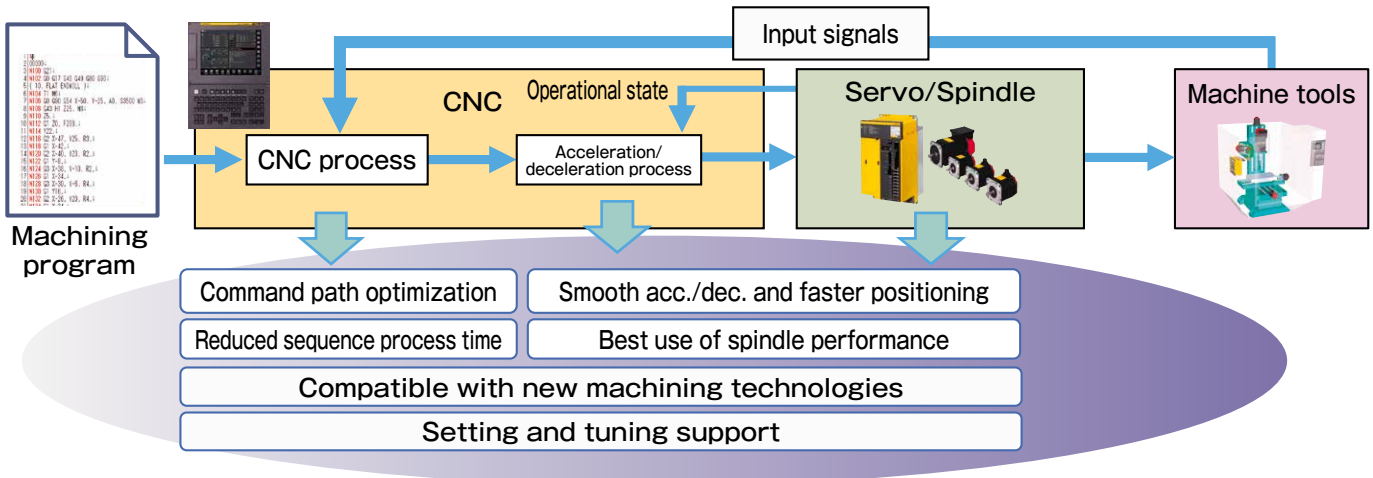

Fast Cycle-time setting

Easily reduce cycle times

The Fast Cycle-time setting compares the currently set parameter setting to the FANUC default setting, allowing you to easily use the setting that most effectively reduces cycle time.

PARAMETER	STANDARD
T2 USED FOR BELL-SHAPED ACC/DEC G0	100 msec
SERVO LOOP GAIN	5000.01/sec
IN POSITION WIDTH	0.100mm
VELOCITY CONTROL METHOD	1
FEED-FORWARD FUNCTION	1
VELOCITY LOOP RAMP CYCLE MANAGEMENT	1
VELOCITY FEED-FORWARD COEFFICIENT	100%
VELOCITY RAMP COEFFICIENT FOR CUTTING	99.99%
VELOCITY RAMP COEFFICIENT FOR CUTTING	100.00%
VELOCITY FEED-FORWARD COEFFICIENT	100%

Reduced cycle time example:
Workpiece for evaluation

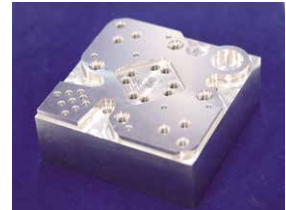

Before application 4 minutes 47 seconds → After application 4 minutes 4 seconds
Approx. 15% reduction

Smart Servo Control

Smart Servo Control is a group of functions to optimize control in real time according to the change of machine conditions such as load and temperature. These functions contribute to high-speed, high-precision and high-quality machining as the control technology supporting Fast Cycle-time Technology and Fine Surface Technology.

Smart Spindle-load Control

Smart Rigid Tapping

Smart Thermal Control

Smart Feed-axis Acc/Dec

Smart Spindle Acc/Dec

Smart Load Meter

Smart Overlap

Smart Backlash Compensation

Smart Machining Point Control

Fine Surface Technology

Fine Surface Technology is a collective term for CNC and servo technologies that achieve fine surface machining. This technology allows for the interpolation of high precision machining program output from CAD/CAM, high-speed execution of small segment programs, the generation of a smooth tool path and accurate command follow-up. These tasks more efficiently by taking digital technology.

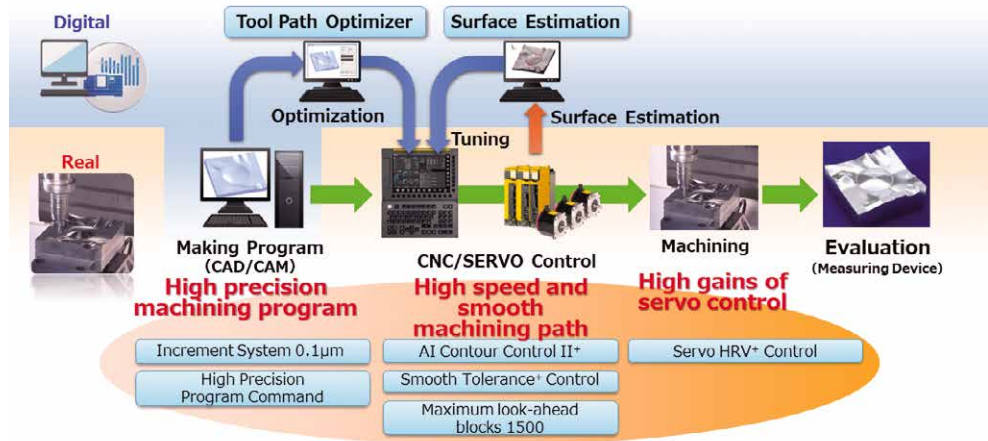

Fine Surface settings

Standard setting values are provided based on machining conditions (roughing, semi-finishing, or finishing), and slide bars can be intuitively used to set and adjust high-speed, high-precision machining parameters based on the machine. Machining under optimal conditions can be achieved by selecting machining processes during the machining itself using a machining program or screen operations.

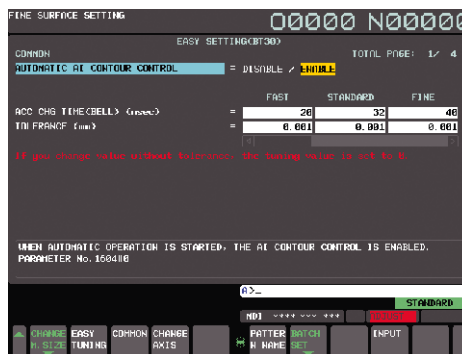

Smooth Tolerance+ Control

Smoothing continuous small blocks to realize fine surface machining

The machining path specified in continuous small blocks, like the one for mold machining, is smoothed out within the specified allowance error tolerance.

The smooth machining path reduces mechanical shock and improves the quality of the machined surface.

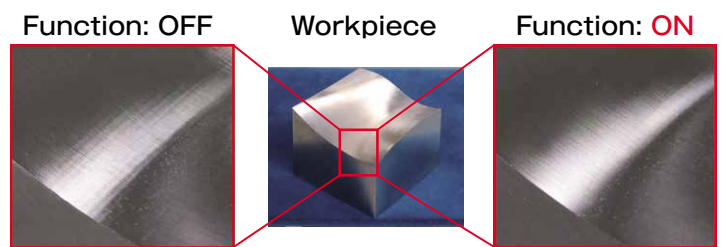

Joints of blocks are visible

Smooth machined surface

Servo Learning Control/ Servo Learning Oscillation

Servo learning control enables high-speed, high-precision machining of workpieces that require repeatable cutting commands, such as aspherical workpieces, gears, and so on. Servo learning oscillation that applies servo learning control also accurately tracks oscillation commands with a high frequency, thereby achieving dependable chip shredding.

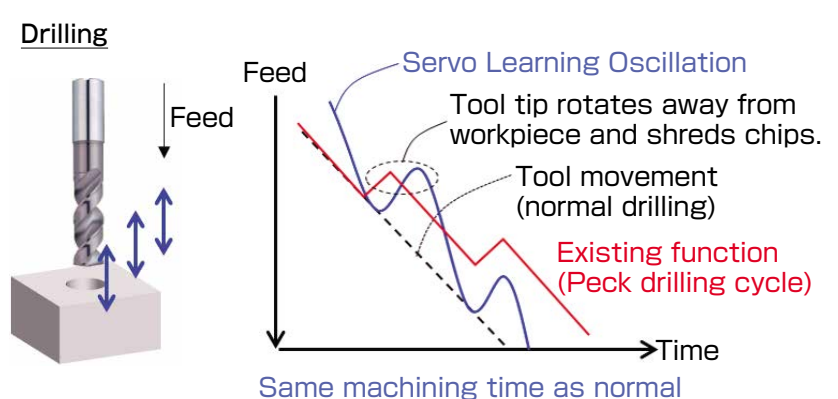
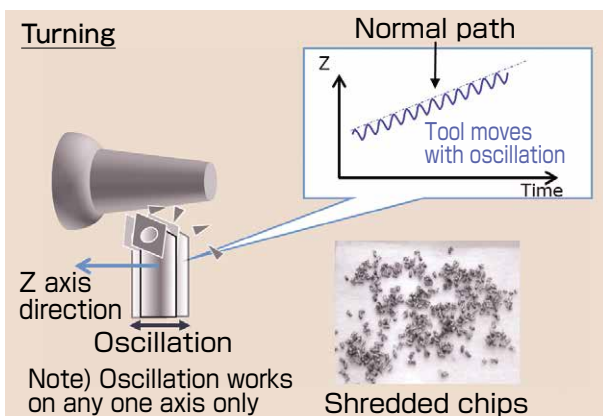

Excellent control function

Machining Performance

Smooth TCP

Simultaneous 4-axis machining including the rotation axis is available with the program that specified tool center point path.

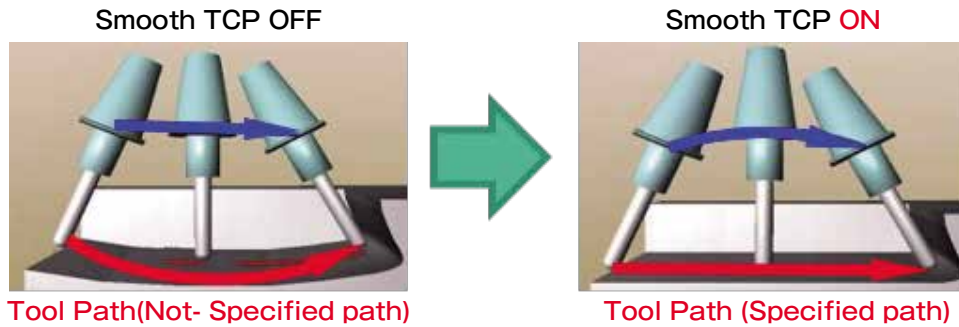

Tool center point path follows specified path with high accuracy interpolation. This function can achieve smooth machining of complicated shapes including undercuts like an impeller that cannot be machined with 3 axes. Tool offset and kinematic conversion applied to a rotary-axis are executed by CNC. So that, a machine configuration is not needed to consider on the CAM side, and it improves affinity with CAD/CAM.



Excellent Operability

Ease of Use

Large Capacity Program Memory

You can use large capacity program memory that can store large sized programs. Programs stored in program memory can be operated by memory operation. Also, editing can be done.

Extended Program Memory (CF card)

Using a CF card installed in the memory card slot of the display unit as program memory.

- Maximum capacity is about 2GB.
- Recommended if you use a standard display unit.
- Having excellent cost performance.
- Total number of programs and folders that you can register has expanded to 1000.

Extended Program Memory (PC)

Using the HDD/SSD of a PC like PANEL *iH/iH Pro* as program memory.

- Maximum capacity is 40GB.
- Recommended if you use a display unit with PC function like PANEL *iH/iH Pro*.
- Having excellent cost performance.
- High speed GOTO jump and high speed search can be done.

Utilization of USB Memory

Load & Go function

- Programs on USB memory can be operated easily by the Load & Go function.
- Copy from USB memory & selection to the main program is completed with one touch.

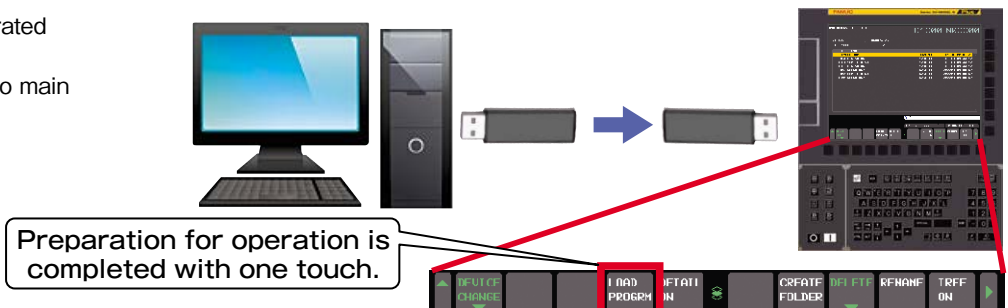

FANUC *i*HMI

FANUC *i*HMI supports all jobs at shop floor consistently, exceeding a limit of conventional CNC operation. For the flow of "planning," "machining," and "improvement." process, various functions such as tool data registration, machining time prediction, programming, and post-machining inspection has been provided.

Any of them can be easily operated by intuitive operability. In addition, at the center of each function is the home screen, which can be displayed from any screen with a dedicated key, so there is a sense of security that you can return at any time.



CNC operation

The CNC operation screen has been consolidated into three screens, "programming", "setup", and "machining", which reduces screen switching operations and greatly improves operability. In CNC operation screen, machining programs can be easily recognized and easily created, such as color-coded display for each command and comment input function for tool information.

- G-code Guidance enables easy programming with machining selection and input screen even if complex command. It reduces program creation time and errors.
- Machining program preview detect a programming errors before machining. It Reduces working time and costs.
- The help, troubleshooting, and other functions are available to solve problems at a time if you have difficulty.

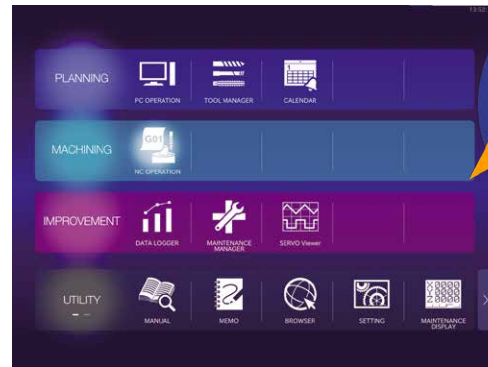

HOME screen

Tool manager

- Tool data of each application of FANUC *i*HMI can be centrally managed and all the tool data can be referred here.
- By reading the catalog data provided by tool makers, such as mold model number, dimensions, and machining conditions of the tool, the time to enter the tool data can be reduced.

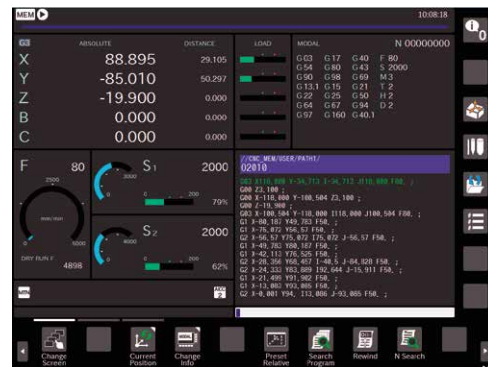

CNC operation screen

Maintenance manager

- Prevent check leak of maintenance parts by collective management of maintenance parts for machines and for CNC, amp, and motor.
- Prevent errors by working maintenance with checking the maintenance manual.

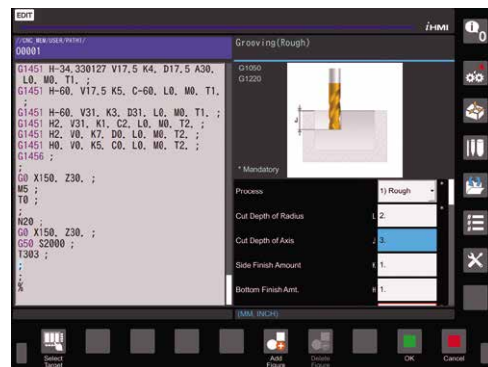

G-code Guidance

SERVO VIEWER

- SERVO VIEWER offers the waveform display of the machine operation such as position of feed axes and torque of spindle.
- PMC signals and sequence numbers can be observed simultaneously.
- Useful for reducing cycle time and improving cutting condition, without any additional equipment.

Manual viewer

- Not only CNC manuals, but also machine manuals and work procedure manuals can be registered.
- You can check it in front of the machine without having to look for a paper manual or return to your office computer.

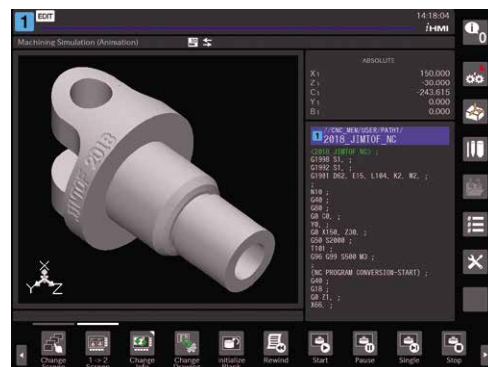

Machining program preview

Many Customizable Functions

Ease of Use

Customizable functions are available, which allow machine tool builders to customize their own machine tools

Customizing operation screens

FANUC PICTURE

This tool enables you to create a machine operation screen simply by pasting screen components such as buttons and lamps on the PC.

- The screen creation tool is FANUC's proprietary easy-to-use user interface that is optimized for creating screens for CNCs.
- Screens that are created can be displayed and operated on various CNC models.
- Complicated controls such as network communication and file control can be easily implemented by using general-purpose scripts.

In addition, in the PANEL \mathcal{I} series display device, it is possible to create screens that leverage the performance of display devices.

- You can display the font for each language of any desired size.
- You can display buttons, lamps, and high precision images in full color.

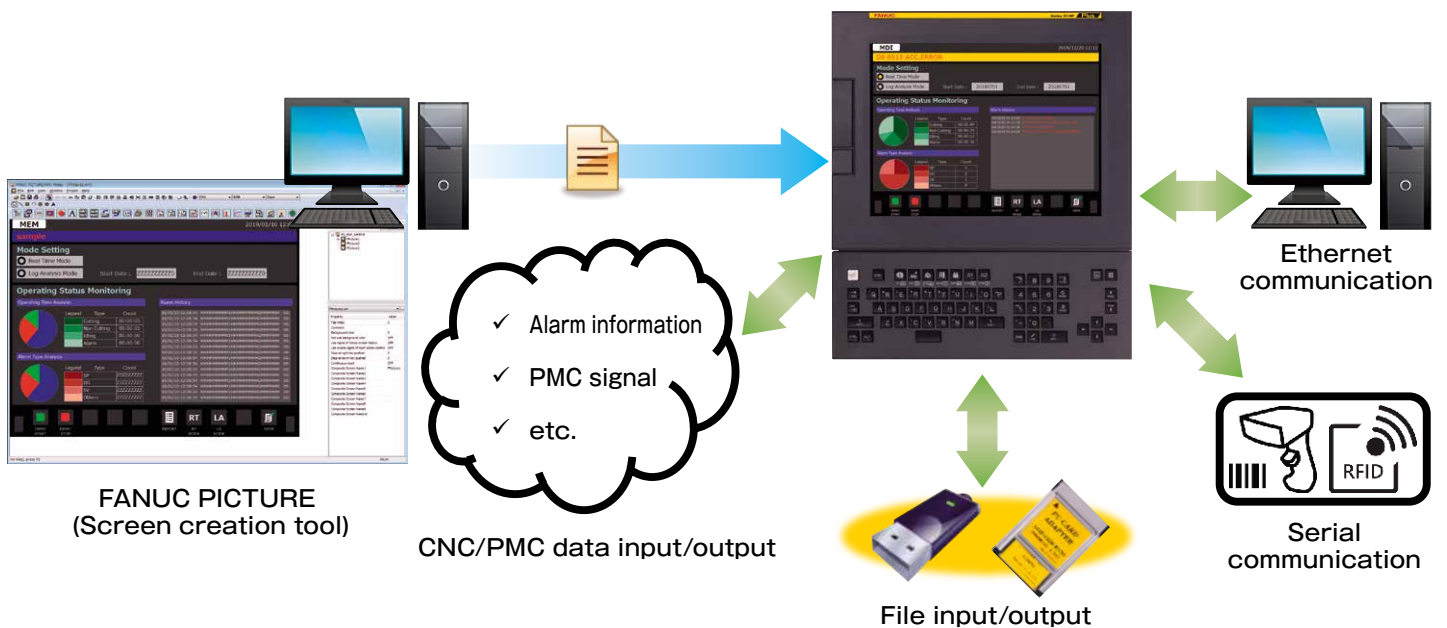

C Language Executor

Machine tool builders can create their own operation screens, which enables unique CNC display and operation.

- C language is used for programming.
- Multi window display enables creation of pop-up menus.
- Operation screens using the touch panel can be created.
- In addition to standard ANSI functions, many functions are available for CNCs and PMCs.
- High-level tasks to which high execution priority is assigned can monitor signal and position information.



Implementing original sequence control based on PMC

FANUC LADDER-III

For machine customization, a machine tool builder's own sequence control can be incorporated into the built-in PMC. A PMC sequence program can be created on a personal computer by using FANUC LADDER-III, a very easy-to-use programming tool with many useful functions.

- A program can be created with ladder and function block.
- A program can be coded using signal names instead of signal addresses.
- Online monitoring and editing can be performed by connecting a personal computer with the CNC via Ethernet.
- Including PMC Function Library which enables you to integrate functions such as PMC axis control easily.

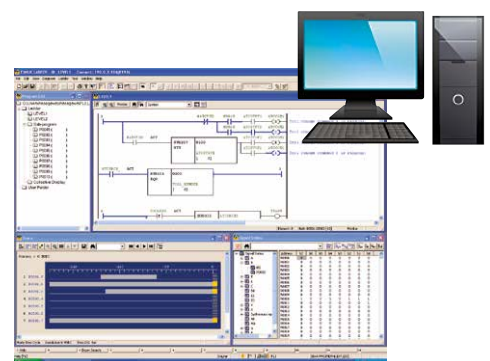

Set-up Guidance Function

Measurement is achieved by touching the tool to the work manually. And the measurement value can be set to the work coordinate system. As a result, the arrangements time can be greatly reduced.

- Single surface measurement
- Outside diameter measurement
- Inside diameter measurement
- Outside width measurement
- Inside width measurement
- Measurement of corner outside
- Measurement of corner inside
- Angled work measurement



Support for adding sensors and peripheral devices

Multi C Language Executor

New custom screens can be easily added without changing the custom screens implemented in the machine (created with FANUC PICTURE or C language Executor).

Ladder Dividing Management Function

Ladders for controlling sensor or peripheral equipment can be added without changing the ladder for machinery control already implemented in the machine.

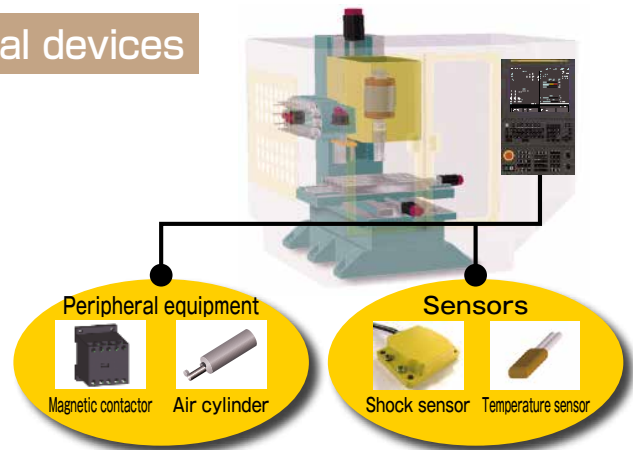

Easy Robots Connection and Control

CNC-QSSR

QSSR (Quick and Simple Startup of Robotization) is function to quickly and easily integrate robots into machine tools. Four functions are available, QSSR CONNECT, QSSR G-CODE, QSSR AUTO PATH and QSSR ON SITE.



QSSR CONNECT

This function makes it easy to connect robots to machine tool, to program and to verify the status of operation.

- Easy connection using one Ethernet cable
- Easy setup using the guidance function

QSSR G-CODE

This function makes it possible to control robots from CNC.

- By using CNC program (G-code commands), robots can be controlled like a loader
- By using familiar machine tool handles, robots can be positioned and taught easily from CNC screen

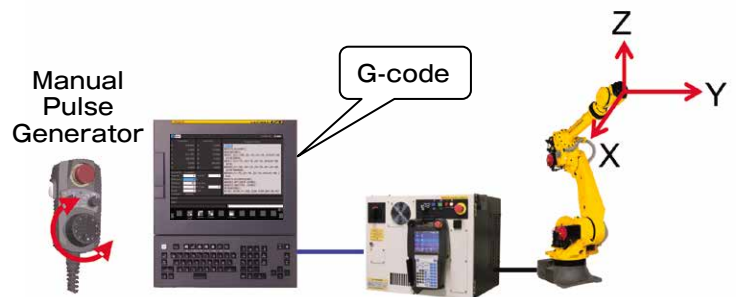

QSSR AUTO PATH

This function makes it possible to automatically generate a robot path that does not interfere with PC tools.

- Automatically generate path that does not interfere with the machine tool just by specifying the start point and end point
- The generated path can be confirmed by simulation, reducing man-hours for teaching robot.



QSSR ON-SITE

Robots can be installed on existing machines without changing machine tools.

- No need to change ladder and software of machine tools
- Interlock CNC with robots via macro variables

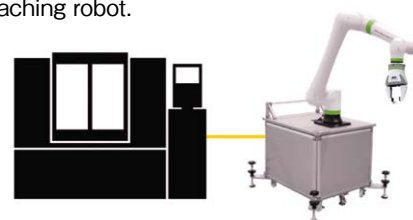

Network Support Functions

Ease of Use

Advancing the IoT adaptability of CNC machine tools with extensive network functions

Ethernet / Industrial Ethernet / Field Network

You can use Embedded Ethernet provided as standard and Fast Ethernet with a communication dedicated processor for NC program transfer and remote maintenance.

Various types of Industrial Ethernet and Field Networks are supported to enable various types of peripheral devices to be connected for controlling peripheral devices such as waterproof I/O devices and collecting sensor information. Via a MULTI SENSOR I/O UNIT or other devices, information of impact, temperature, and other sensors can also be read.

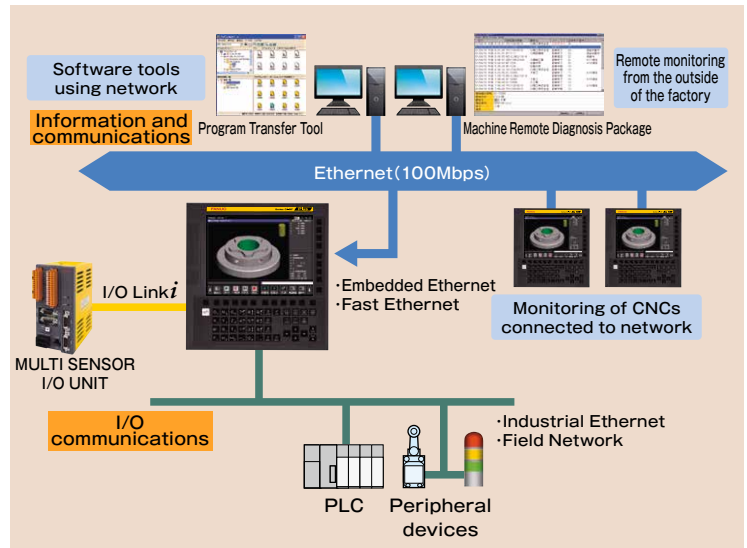

Supported Industrial Ethernet/Field Networks

- FL-net
- EtherNet/IP (master/slave)
- PROFINET (master/slave)
- PROFIBUS-DP (master/slave)
- DeviceNet (master/slave)
- CC-Link (slave)
- Modbus/TCP (slave)
- CC-Link IE Field (slave)

FANUC MT-LINK*i* (Operation Management software)

MT-LINK*i*

MT-LINK*i* is a software product that can collect, manage, and help visualize various information of machines connected via Ethernet. It helps visualize the machines in factories, and contributes to minimizing downtime.

- It can collect device information not only from machine tools equipped with FANUC CNCs, but also from FANUC robot controllers, OPC-compatible PLCs, and MTConnect-compatible machine tools.
- Information of existing devices that do not have Ethernet I/F can also be collected by using an Ethernet I/O converter.
- Many standard screens that display various pieces of information such as the operational states and operational results of machines are available.

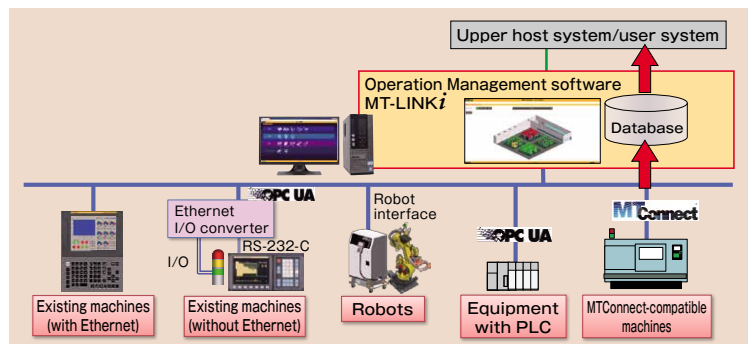

Standard screen example)



Overview screen



Operational results screen

Visualization of machine operation

By using MT-LINK*i* together with SERVO VIEWER, servo data and various status signals are collected, achieving the visualization of detailed machine operations.

- High-speed sampling (1ms) servo data is efficiently collected from multiple machine tools.
- Various schedule and trigger functions enable efficient analyses by collecting only required data at the right timing.

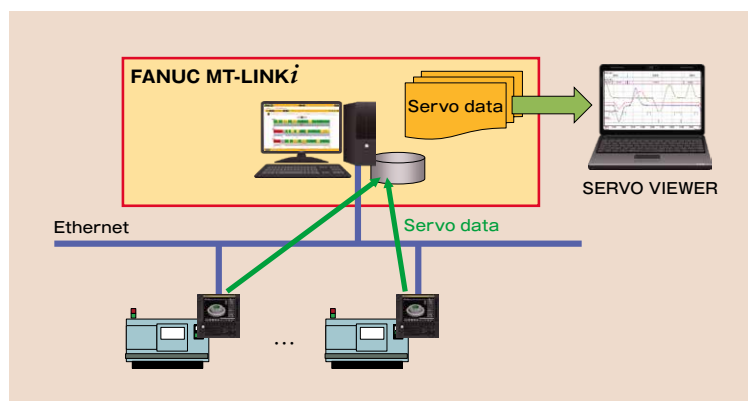

High-Speed, Large Capacity, and Multi-path PMC

High-Speed and Large Capacity

The integrated PMC now achieves even higher speeds. Large-scale sequence controls can be processed at high speed using the powerful dedicated processor and the latest custom LSI.

- Program capacity Max. 100,000 steps (Total of all PMC paths)
- Internal relay (R) Max. 60,000 bytes
- Data table (D) Max. 60,000 bytes
- PMC paths Max. 3 paths (Max. 16 ladder programs)

Multi-path PMC

One PMC can execute up to three independent ladder programs, including loader control and peripheral equipment control.

- Ladder programs can easily be developed according to each user's machine configuration.
- Cost reductions are achieved by eliminating external PLCs or other devices for peripheral equipment control.

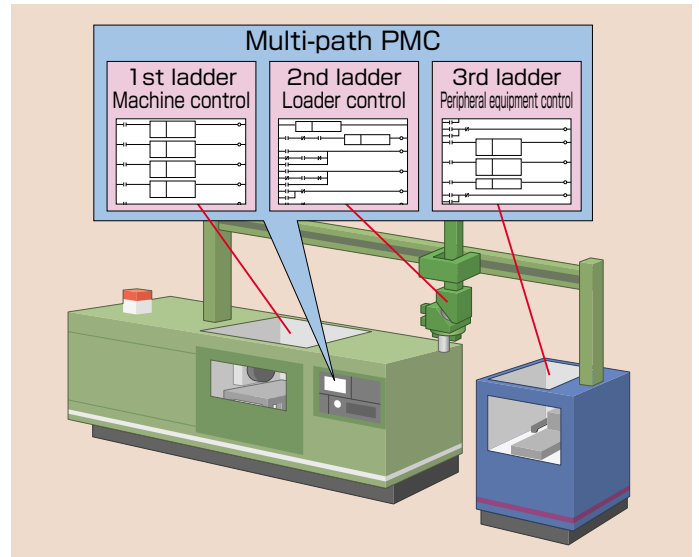

Function Block function

- This function enables repeated ladder circuit patterns to be arranged in function blocks and easily reused.
- The PMC function libraries attached to FANUC LADDER-III include functions ready for immediate embedding such as PMC axis and peripheral equipment control, and can be freely customized.

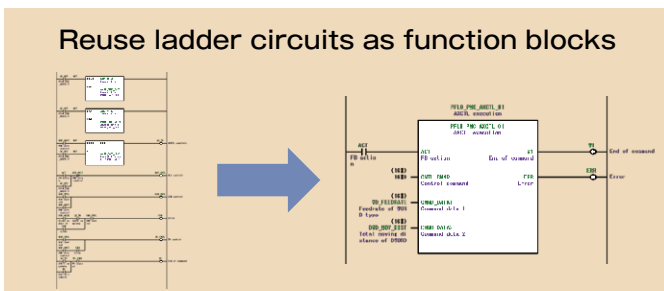

A full range of libraries are included in FANUC LADDER-III

- PMC axis control
- Operator's panel
- Spindle functions
- I/O devices
- CNC functions
- Others

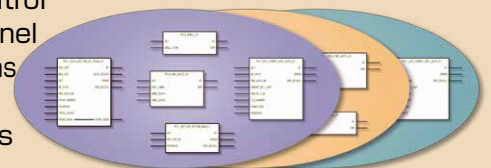

Safety functions

Improvement of the safety of machine tool and machining line

Dual Check Safety Function

This is a safety function integrated into the CNC that conforms to ISO 13849-1 PL d. Multiple processors perform dual monitoring of the actual positions, speed, and safety-related I/O of servo motors and spindle motors, securing a high level of safety by providing duplicated paths for cutting off power.

Network safety function

By combining this function with the Dual Check Safety function, safety functionality of the machining line is achieved.

- Safety function by FL-net
- EtherNet/IP Adapter Safety function
- PROFINET IO Device Safety function

Safe Torque Off (STO) function

This is a safety function integrated in servo amplifiers that conforms to IEC 61800-5-2. Motor power can be safely cut off by the duplicated cut-off path within the amplifier.

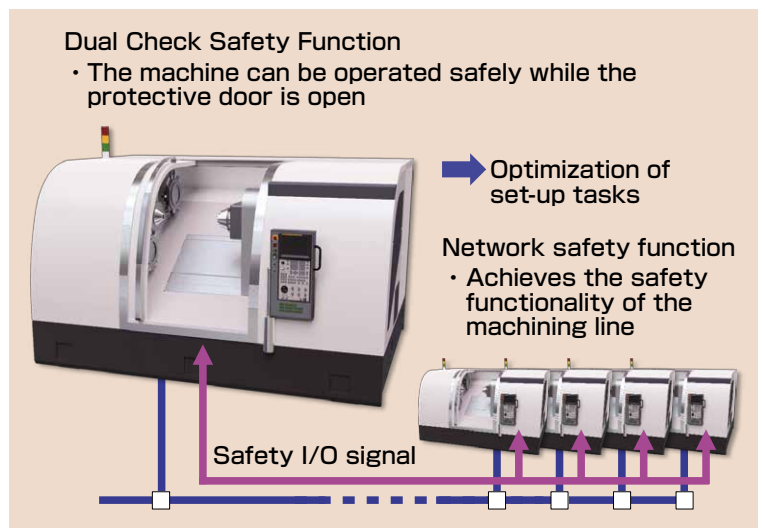

Easy Maintenance

Minimizing Downtime

Functions for minimizing downtime

Contribution to Preventive Maintenance

Leakage Detection Function

In a harsh environment of a cutting coolant, the coolant may infiltrate into a motor and the machine may stop suddenly due to the insulation deterioration.

The Leakage Detection Function built into the amplifier automatically measures the insulation resistance of motors, and detects the insulation deterioration before the machine leads to stop, enabling preventive maintenance.

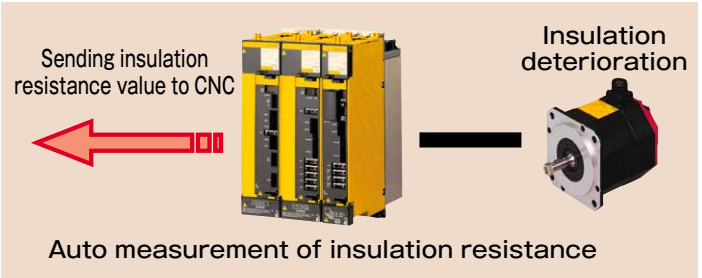

Cooling Fan Warning Function

By monitoring a decrease in the rotational speed of each cooling fan motor of the CNC and the servo amplifier, signs of fan abnormalities can be detected. This function enables preventive maintenance.

Fans are stored in a cartridge and can be replaced quite easily, so maintainability is enhanced.

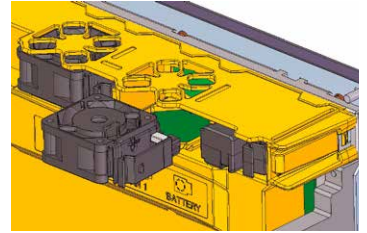

Failure Part Detection

Trouble Diagnostic Function

Various failure detection functions provided to the I/O Link *i* and FSSB can detect interruptions in the power supply to the I/O modules or servo amplifier and identify disconnection locations of the communication cable.

In addition to that, I/O Link *i* can detect the ground fault of each DO.

The trouble diagnosis function enables you to see diagnosis information helpful in determining the status when an alarm occurs on the CNC screen.

- Trouble diagnosis guidance screen
- Trouble diagnosis monitor screen
- Trouble diagnosis graph screen

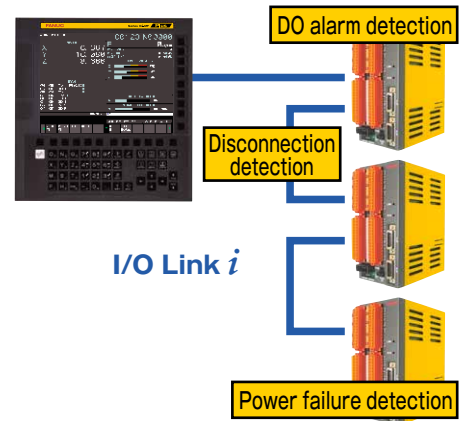
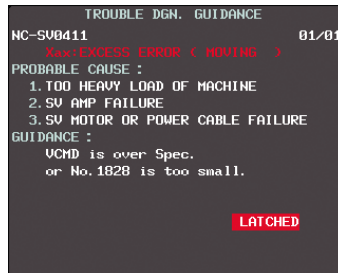

Encoder Communication Check Circuit

This check circuit enables a quick recovery from encoder communication alarm by identifying which part such as encoder, feedback cable or servo amplifier has failed.



Prevent Machine Damage at Power Failure

Machine Protection at Power Failure

Damage of machines and workpieces at power failure is prevented where a power supply is unstable or in a lightning-prone areas.

- Gravity-axis drop prevention
The holding brake of gravity axis are quickly activated by detecting power failure in the circuit incorporated into the amplifier.
- Stop distance reduction*¹⁾
Feed axes are quickly stopped to avoid a crash in high-speed machine tools.
- Retraction*²⁾
The tool is retracted from the workpiece while keeping synchronization in gear cutting machines and others.

*1), *2) "Power Failure Backup Module (Hardware)" or "Power Failure Backup Function (Software)" shall be applied.

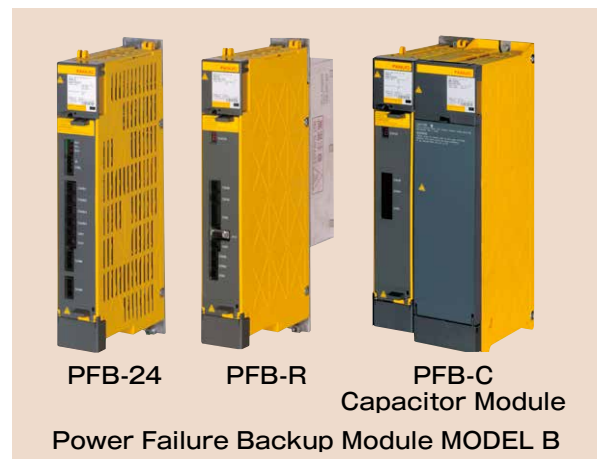

Digital Twin for FANUC CNC

Supporting productivity improvement for machine tool builders and machine users

Supports efficiency for machine tool design, processing and maintenance

FANUC's Digital technology centered on CNC GUIDE2 and SERVO VIEWER are fused with real information such as servo data, to provide as a lot of tools for efficient to streamline a series of processes such as machine design, machining and maintenance.

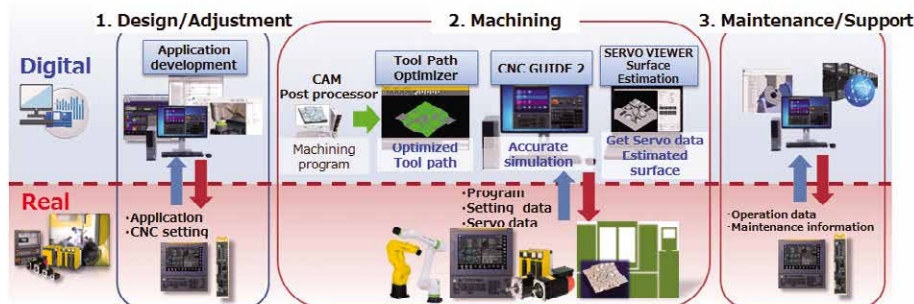

FANUC Tool Path Optimizer

It is a software tool that compensates the tool path of the machining program using the machining shape (CAD data).

- Input the machining program and CAD data, and output the machining program optimized for FANUC CNC.
- It can be optimized regardless of the type of CAM that generated the machining program, and high-quality machining can be achieved.
- The quality of the machined surface is improved by reducing scratches and steps on the machined surface caused by the tool path.

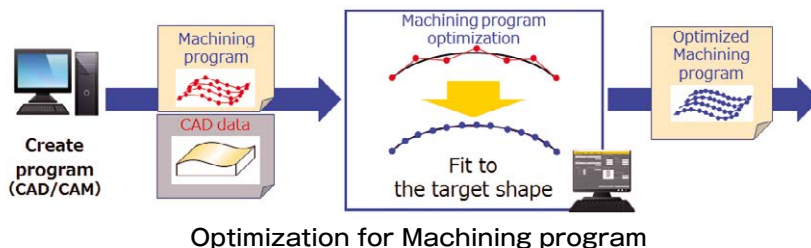

FANUC CNC GUIDE2

It is a software tool that can verify the CNC function on a personal computer. It faithfully reproduces CNC operations such as acceleration / deceleration and smoothing functions, and it can accurately simulate tool paths and machining times.

- In cooperation with Tool Path Optimizer and Surface Estimation, it is possible to optimize the machining program and simulate the machining surface.
- In cooperation with FANUC PICTURE and FANUC LADDER III, it is possible to efficiently develop / debug custom screens and ladder programs. In addition, it can be boiled a CNC simulation environment easily by connecting to CNC and acquiring parameters, programs, customized data of FANUC PICTURE, etc.
- By connecting the MOP simulator that integrates the MDI and the operation panel, it is possible to train CNC operation with the same operation feeling as an actual machine tool.



FANUC SERVO VIEWER Surface Estimation

By dry running the machining program on the machine before actual cutting, the machining surface is estimated from the measured servo position data and tool information of each axis.

- The motion on the machine tool is simulated by digital technology, and the machining result close to the actual machining is estimated.
- Productivity is improved because the quality of the machined surface can be confirmed by dry running without actual cutting.

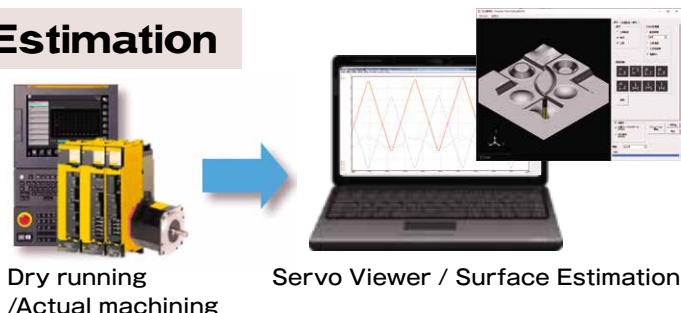

Support of efficient servo tuning for high-speed and high-precision machining

FANUC SERVO GUIDE

FANUC SERVO GUIDE supports you to perform tuning of the servo and spindle in an integrated manner, including creating test programs, setting parameters and measuring data. You can use it easily by connecting a PC to a CNC directly.

In addition to the motions of each servo axis and spindle axis, you can observe program execution status inside the CNC and PMC signals as waveform data and analyze the machine operation in detail. Continuous measurement for a long period is also possible. Tuning Navigator offers automatic process for tuning gain, filter and others and enable you to perform the advanced servo tuning in a short time. The automatic tuning function for protrusion compensation significantly shortens the time of tuning for high-speed and high-precision.

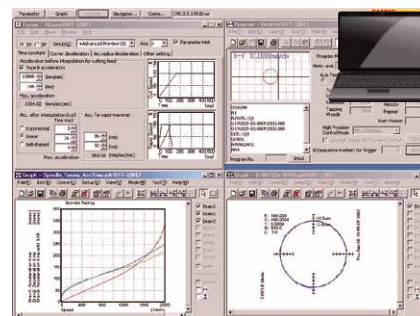

Service & Support

Excellent Maintenance Services

FANUC service team delivers customer trust and confidence based on direction of service “Maximizing Uptime”, “Global Service” and “Lifetime maintenance”.

Service First

Conforming to the spirit of “Service First”, FANUC provides lifetime maintenance to its products for as long as they are used by customers, through more than 260 service locations supporting more than 100 countries and regions throughout the world.

Maximizing Uptime



FANUC ACADEMY

FANUC ACADEMY operates versatile training courses to develop skilled engineers effectively in several days.



FANUC CORPORATION

● Overseas Affiliated Companies

FANUC America Corporation

FANUC Europe Corporation, S.A.

BEIJING-FANUC Mechatronics CO., LTD

KOREA FANUC CORPORATION

TAIWAN FANUC CORPORATION

FANUC INDIA PRIVATE LIMITED

Phone: (+1)248-377-7000

Phone: (+352)727777-1

Phone: (+86)10-6298-4726

Phone: (+82)55-278-1200

Phone: (+886)4-2359-0522

Phone: (+91)80-2852-0057

● Headquarters 3580, Shibokusa, Oshino-mura,
Minamitsuru-gun Yamanashi, 401-0597, JAPAN
Phone: (+81)555-84-5555 <https://www.fanuc.co.jp/>

<https://www.fanucamerica.com/>

<https://www.fanuc.eu/>

<http://www.bj-fanuc.com.cn/>

<https://www.fkc.co.kr/>

<https://www.fanuctaiwan.com.tw/>

<https://www.fanucindia.com/>

• All specifications are subject to change without notice.
• No part of this catalog may be reproduced in any form.
• The products in the FANUC Series 0i-MODEL F Plus listed in this catalog are not subject to Items 2 to 15 in the Attachment to the Foreign Exchange Order of the “Foreign Exchange and Foreign Trade Law” but are subject to Item 16 (catch-all controls).
The export from Japan may be subject to an export license by the government of Japan.
Further, re-export to another country may be subject to the license of the government of the country from where the product is re-exported. Furthermore, the product may also be controlled by re-export regulations of the United States government.
Should you wish to export or re-export these products, please contact FANUC for advice.